

Data Sheet



Article number: 02140000029

Description: Sealing Clamp S 29 W1

Measures

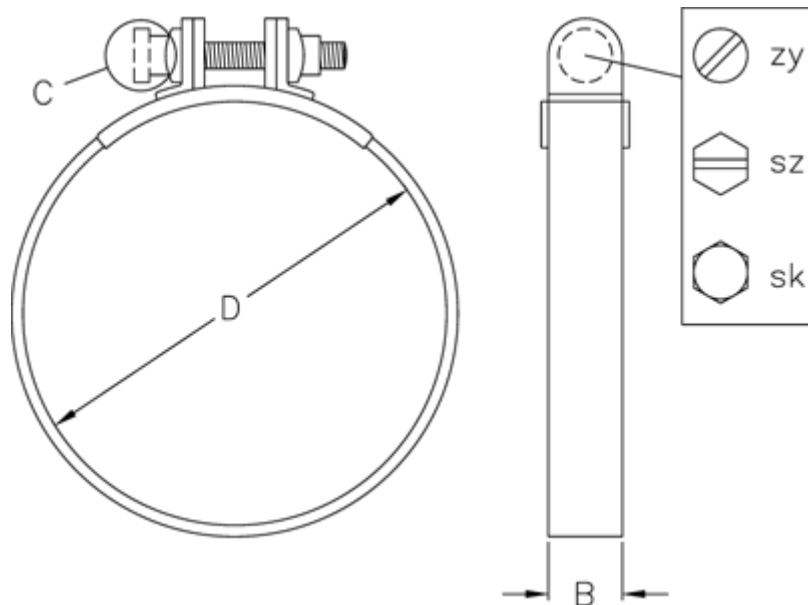

C (screw type) = SZ

Diameter D = 29

Width B = 15